

Classic Series Printer Slotter range

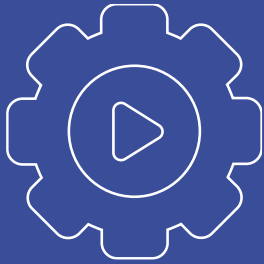

TCY Classic Series



MOTORIZED

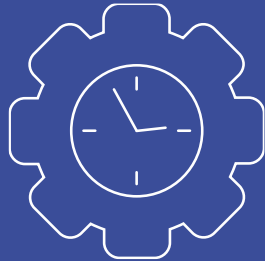

EFFICIENT

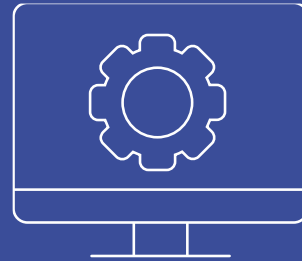

FAST SETUP



EASY MAINTENANCE

Feeding Section

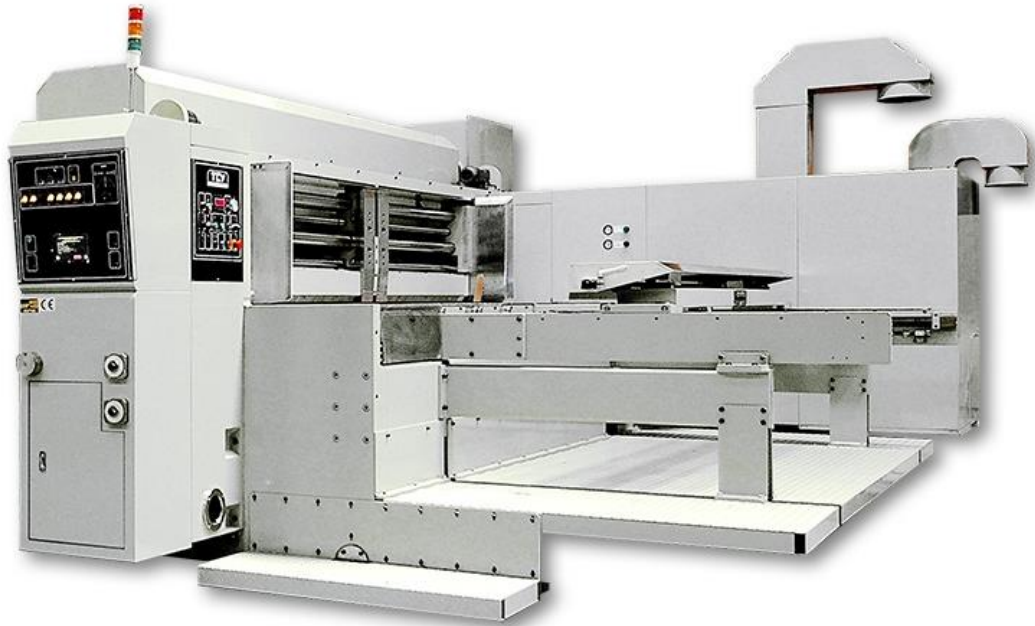

- SUN Lead edge feeder
- Skip Feed and Feed Interrupt
- One touch Auto zero set for feeding position
- Gap adjustment via eccentric device
- Frequency inverter drive with variable suction control
- Optional dust vacuum cleaner
- Optional Pre-Feeder

Printing Section



- Bottom print (Optional Top print for inside)
- Highly accurate print to print registration
- Laser engraved ceramic anilox roll
- ARO pumps for stable ink viscosity and flow
- Rubber roll as standard
- Ink chamber option with double doctor blade and 3-minute auto wash down system
- Vacuum transfer with specially coated wheels
- Optional Print section slide out on tracks for ease of maintenance

Dual Slotter Creaser Section



- Double slotting shafts for leading knives and trailing knives
- Crush – slot – score – slot layout including tab cutters
- Heavy duty design for large strong box use
- Push button Auto-zero set
- Standard digital counter with preset one order, auto slotting positioning
- High grade ball screw shaft
- Optional – central yoke head, moveable

Delivery Section – Options

Optional Vibration Section

- Installs in front of the Stacker
- Vibrating belts can be adjusted by independent motor
- Air blade
- Motorized transfer belts

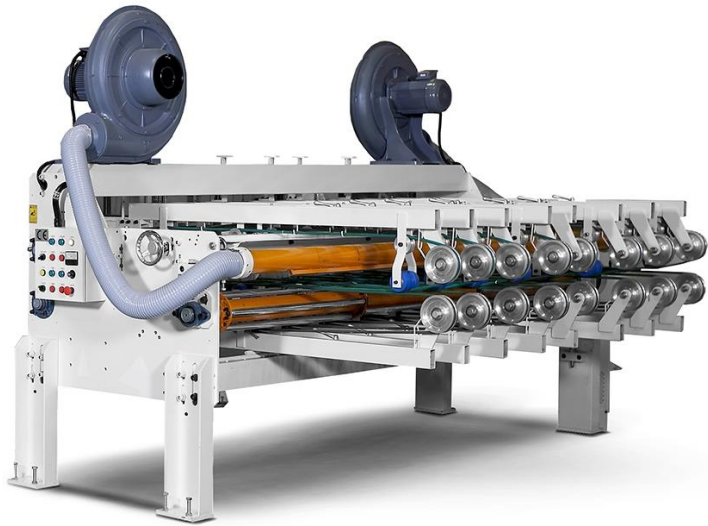

Stacker II

- Reduce operators
- Pile height of 1700mm max
- Optional side squaring device

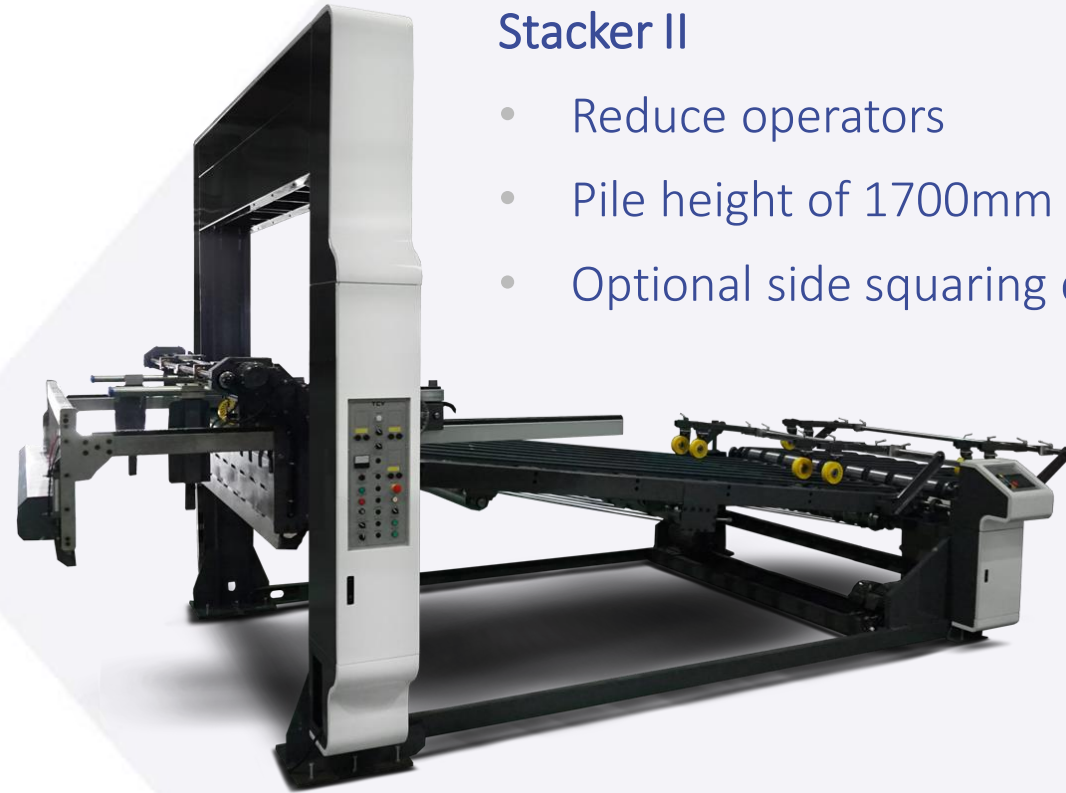

Delivery Section – Multi-out Bundle Stacker

- Vacuum transfer conveyor
- Clean boxes by vibration belts and brushes in stripper unit
- Accurately separate and direct individual blanks into separate streams
- Photo eye counting and batching
- Integrated PLC and servo motor drive for full control
- Multi-out stacking
- Easy operator set up by touch screen

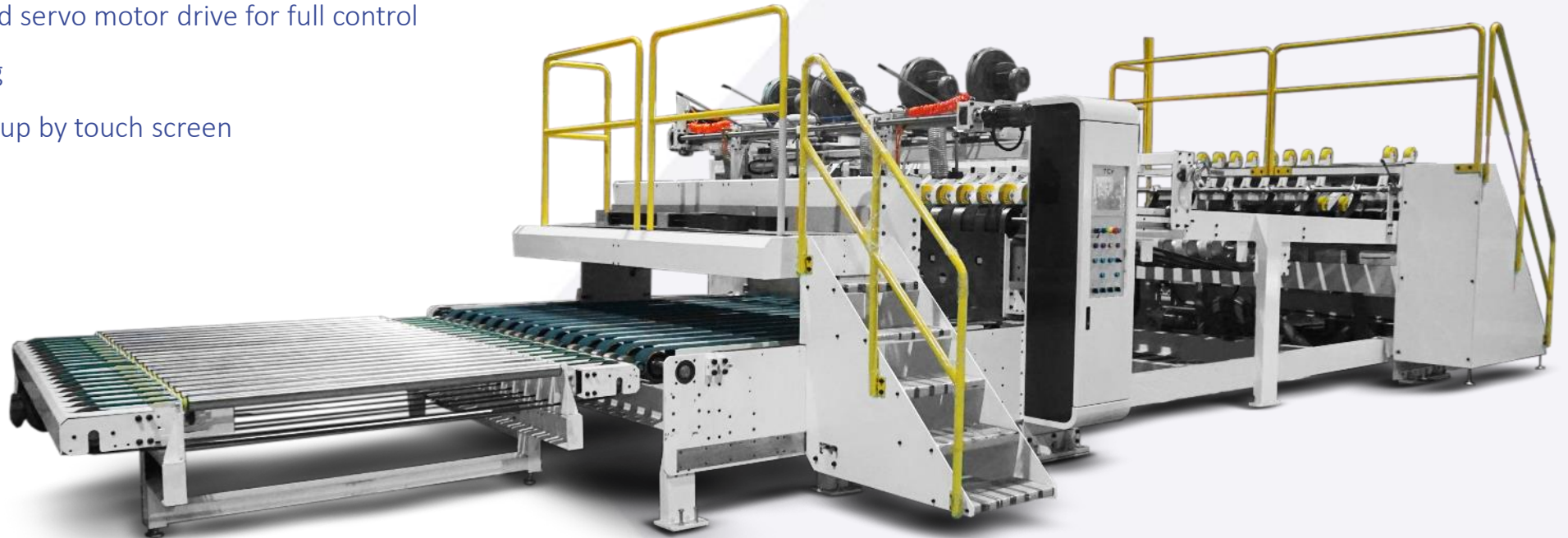

TCY CLASSIC SERIES VALUE



Motorized
Easy set up



EASY MAINTENANCE
Reduce Cost

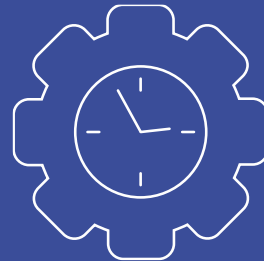

SPEEDY
PRODUCTION

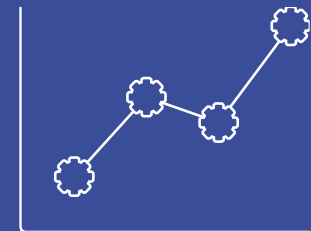

EFFICIENCY UP

TCY Classic Series Printer Slotter

Fast Set - Easy to Operate - Easy to Maintain - High Performance – Quality Production, Consistently



plus...TCY Machinery UK Ltd – Get the most from your Classic Series

- 100% owned subsidiary of TCY
- Factory, Warehouse and Demo centre in West Yorkshire
 - Dedicated TCY OEM parts in stock
 - In house Technical Support
 - Field-based service engineer expertise